

Analog Devices Welcomes Hittite Microwave Corporation

NO CONTENT ON THE ATTACHED DOCUMENT HAS CHANGED



THIS PAGE INTENTIONALLY LEFT BLANK



GaAs SMT PHEMT LOW NOISE AMPLIFIER, 6 - 20 GHz

Typical Applications

The HMC565LC5 is ideal for use as a LNA or driver amplifier for:

- Point-to-Point Radios
- Point-to-Multi-Point Radios & VSAT
- Test Equipment and Sensors
- Military & Space

Features

- Noise Figure: 2.5 dB
- Gain: 21 dB
- OIP3: 20 dBm
- Single Supply: +3V @ 53 mA
- 50 Ohm Matched Input/Output
- RoHS Compliant 5 x 5 mm Package

Functional Diagram

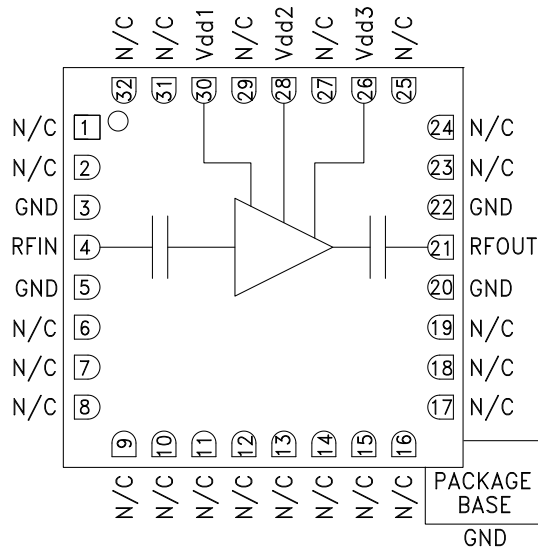

General Description

The HMC565LC5 is a high dynamic range GaAs pHEMT MMIC Low Noise Amplifier housed in a leadless RoHS compliant 5x5mm SMT package. Operating from 6 to 20 GHz, the HMC565LC5 features 21 dB of small signal gain, 2.5 dB noise figure and IP3 of +20 dBm across the operating band. This self-biased LNA is ideal for microwave radios due to its single +3V supply operation, and DC blocked RF I/O's.

Electrical Specifications, $T_A = +25^\circ C$, $V_{dd 1, 2, 3} = +3V$

Parameter	Min.	Typ.	Max.	Min.	Typ.	Max.	Units
Frequency Range	6 - 12		12 - 20				GHz
Gain	19	21		16	18.5		dB
Gain Variation Over Temperature		0.025	0.035		0.025	0.035	dB/ °C
Noise Figure		2.5	2.8		2.5	3	dB
Input Return Loss		15			12		dB
Output Return Loss		13			15		dB
Output Power for 1 dB Compression (P1dB)	8	10		9	11		dBm
Saturated Output Power (P _{sat})		11			13		dBm
Output Third Order Intercept (IP3)		20			21		dBm
Total Supply Current (I _{dd})(V _{dd} = +3V)		53	75		53	75	mA

GaAs SMT PHEMT LOW NOISE AMPLIFIER, 6 - 20 GHz

Broadband Gain & Return Loss

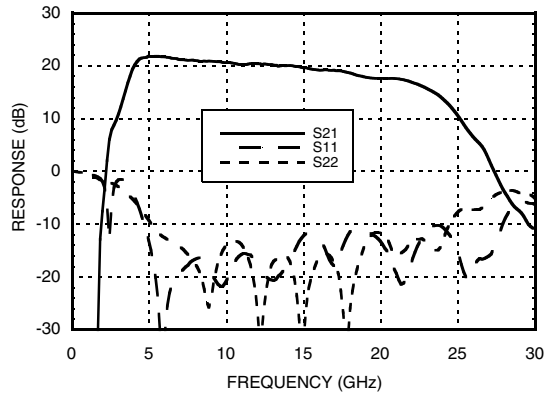

Gain vs. Temperature

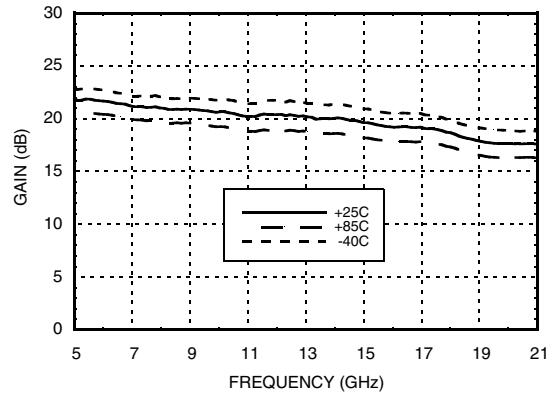

Input Return Loss vs. Temperature

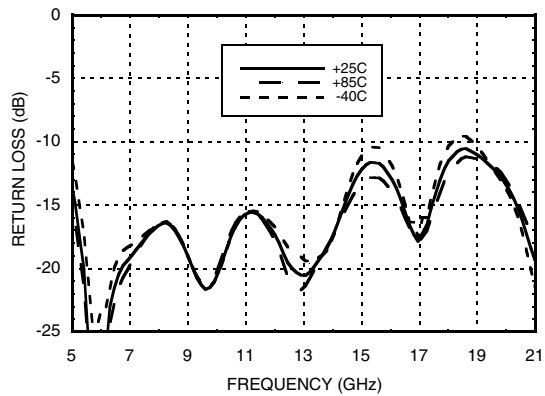

Output Return Loss vs. Temperature

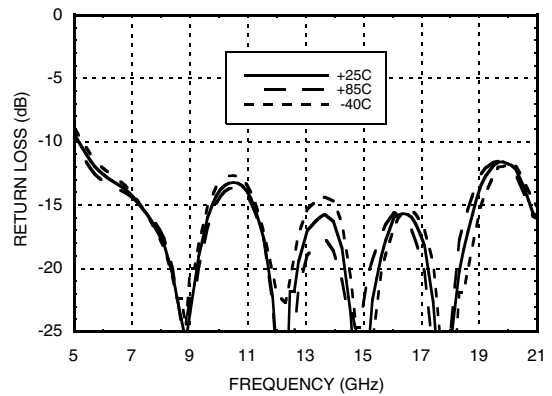

Noise Figure vs. Temperature

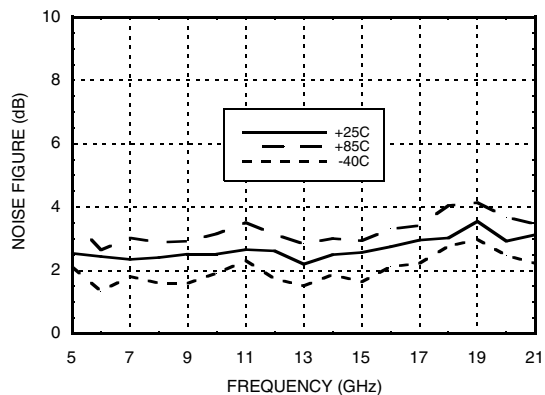

Output IP3 vs. Temperature

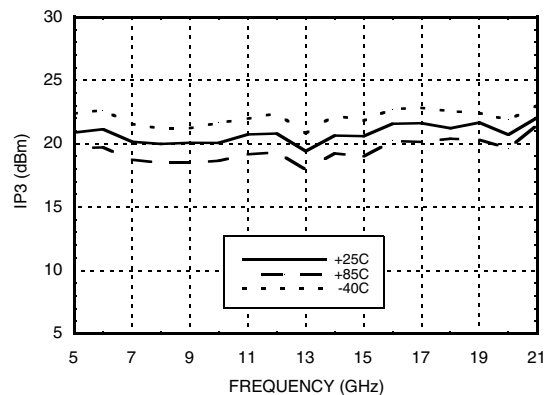



GaAs SMT PHEMT LOW NOISE AMPLIFIER, 6 - 20 GHz

LOW NOISE AMPLIFIERS - SMT

P1dB vs. Temperature

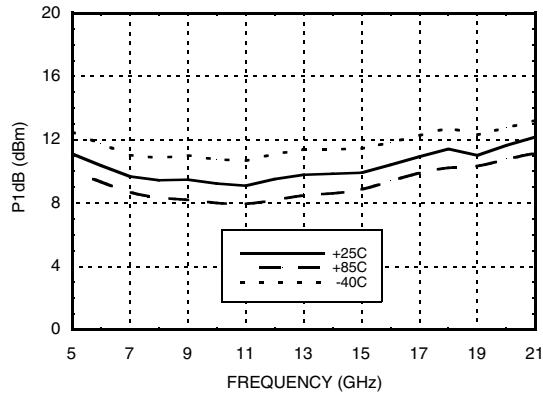

Psat vs. Temperature

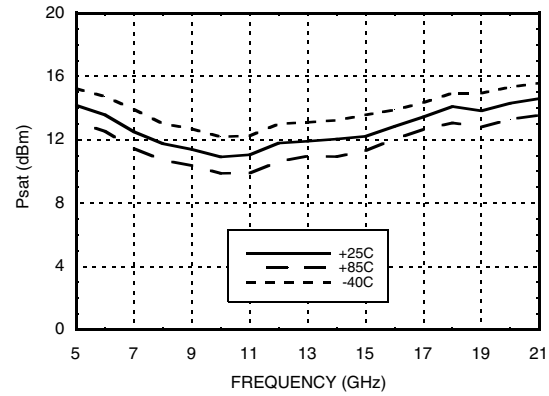

Reverse Isolation vs. Temperature

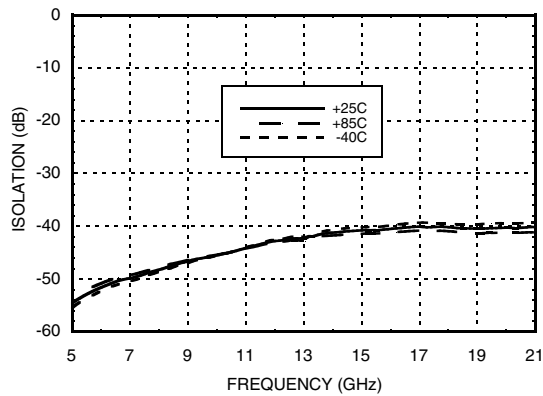

Power Compression @ 12 GHz

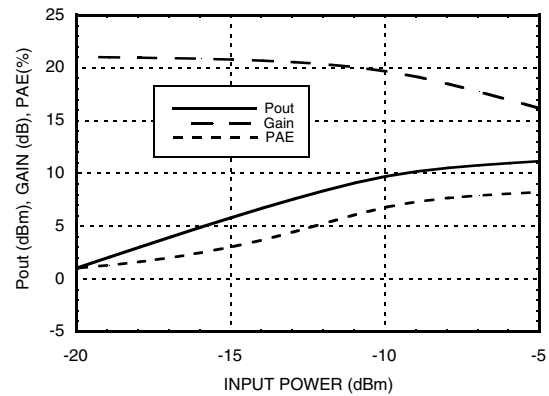

Gain, Noise Figure & Power vs. Supply Voltage @ 12 GHz

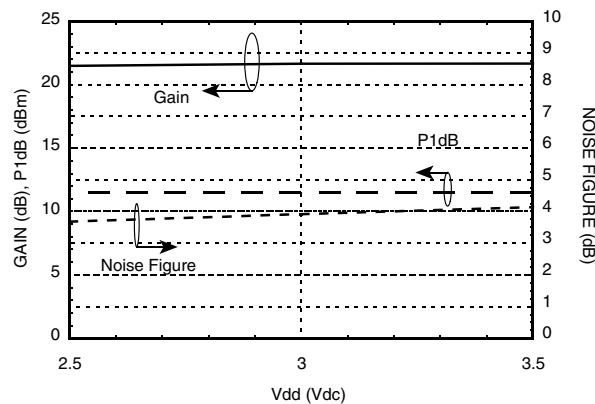

GaAs SMT PHEMT LOW NOISE AMPLIFIER, 6 - 20 GHz

Absolute Maximum Ratings

Drain Bias Voltage (Vdd1, Vdd2, Vdd3)	+3.5 Vdc
RF Input Power (RFIN)(Vdd = +3.0 Vdc)	0 dBm
Channel Temperature	175 °C
Continuous P _{diss} (T= 85 °C) (derate 8.5 mW/°C above 85 °C)	0.753 W
Thermal Resistance (channel to ground paddle)	119.5 °C/W
Storage Temperature	-65 to +150 °C
Operating Temperature	-40 to +85 °C
ESD Sensitivity (HBM)	Class 1A

Typical Supply Current vs. Vdd

Vdd (V)	I _{dd} (mA)
+2.5	51
+3.0	53
+3.5	56



ELECTROSTATIC SENSITIVE DEVICE
OBSERVE HANDLING PRECAUTIONS

Outline Drawing

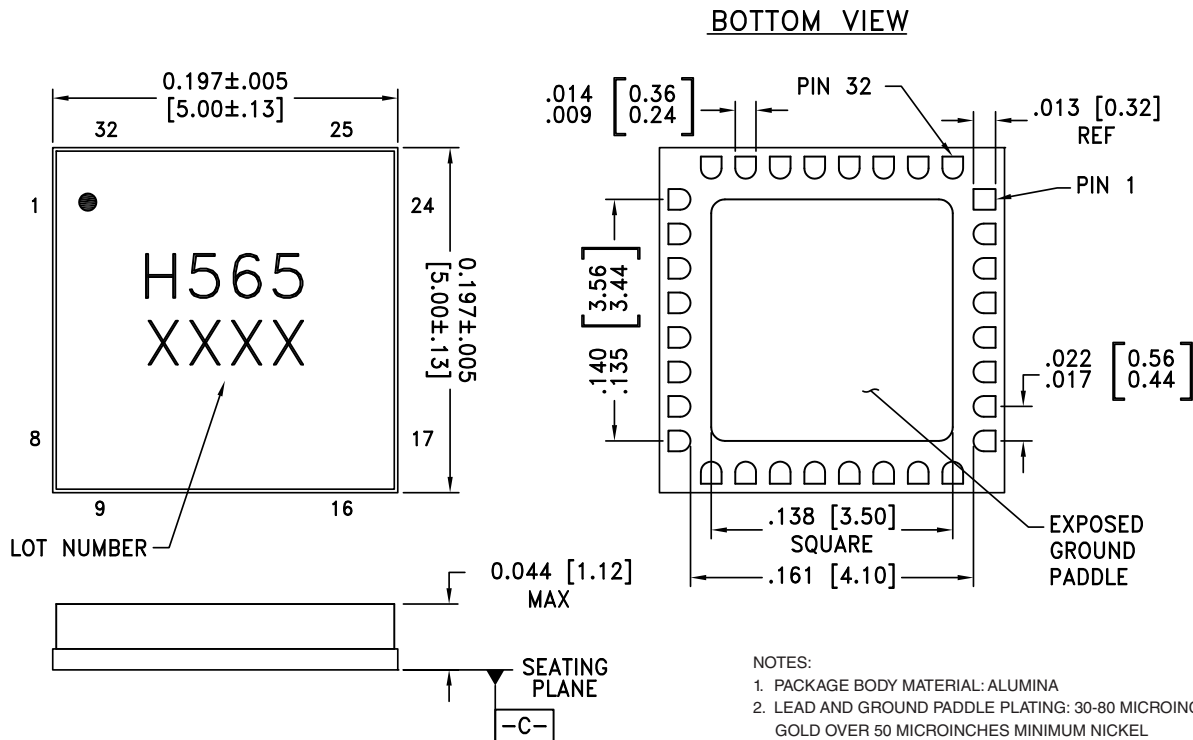

Package Information

Part Number	Package Body Material	Lead Finish	MSL Rating	Package Marking ^[2]
HMC565LC5	Alumina, White	Gold over Nickel	MSL3 ^[1]	H565 XXXX

[1] Max peak reflow temperature of 260 °C

[2] 4-Digit lot number XXXX

Pin Descriptions

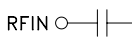
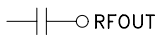
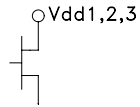
Pin Number	Function	Description	Interface Schematic
1, 2, 6 - 19, 23 - 25, 27, 29, 31, 32	N/C	This pin may be connected to RF/DC ground. Performance will not be affected.	
3, 5, 20, 22	GND	These pins and package bottom must be connected to RF/DC ground.	
4	RFIN	This pin is AC coupled and matched to 50 Ohms.	
21	RFOUT	This pin is AC coupled and matched to 50 Ohms.	
30, 28, 26	Vdd1, 2, 3	Power Supply Voltage for the amplifier. External bypass capacitors of 100 pF and 2.2 μF are required.	

Application Circuit

Component	Value
C1, C2, C3	100 pF
C4, C5, C6	2.2 μF

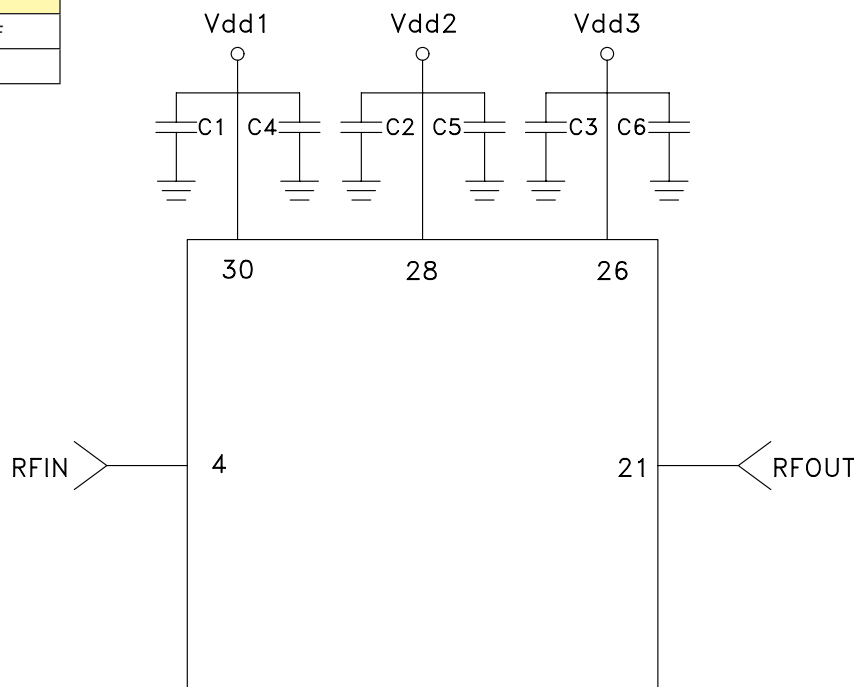

Evaluation PCB

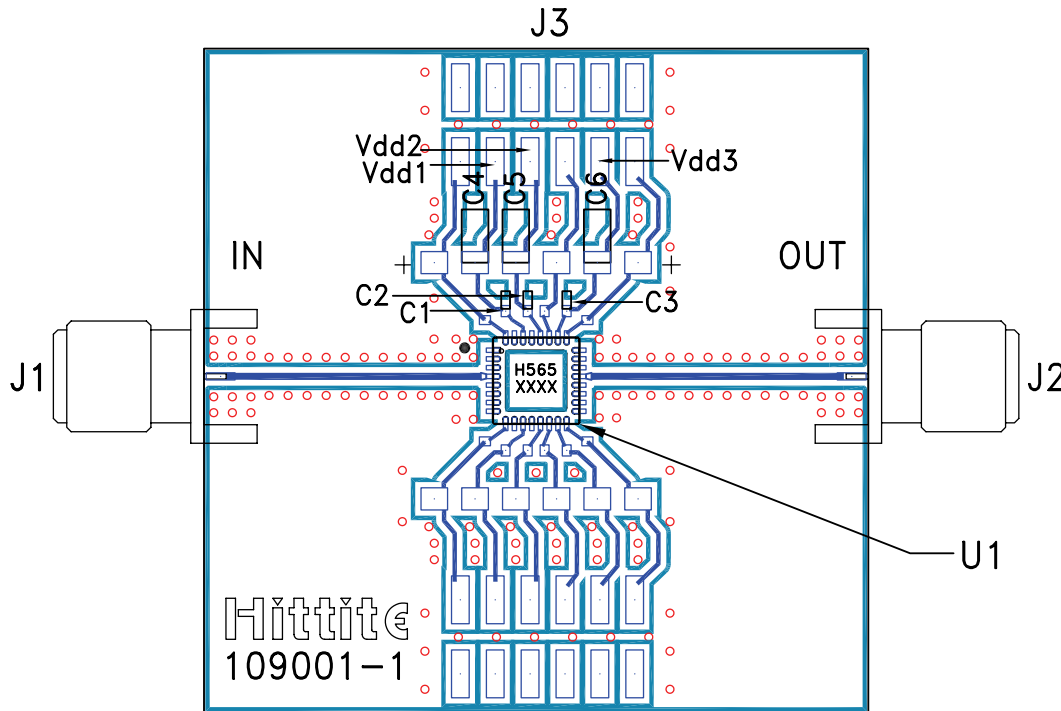

List of Materials for Evaluation PCB 110431 [1]

Item	Description
J1 - J2	PCB Mount K Connector
J3	2 mm DC Header
C1 - C3	100 pF Capacitor, 0402 Pkg.
C4 - C6	2.2 μF Capacitor, Tantalum
U1	HMC565LC5 Amplifier
PCB [2]	109001 Evaluation PCB

[1] Reference this number when ordering complete evaluation PCB

[2] Circuit Board Material: Rogers 4350

The circuit board used in the application should use RF circuit design techniques. Signal lines should have 50 Ohm impedance while the package ground leads and exposed paddle should be connected directly to the ground plane similar to that shown. A sufficient number of via holes should be used to connect the top and bottom ground planes. The evaluation board should be mounted to an appropriate heat sink. The evaluation circuit board shown is available from Hittite upon request.